



*Sprint*  
Pro

## Multi-function Flue Gas Analyser





# User Manual

**M07723**

May 2021

Issue 4

## Summary of Screen Icons

	Select, pick or action
	Up item or entry
	Down item or entry
	Left field
	Right field
	Zero pressure
	Start timed test
	Stop timed test
	Restart timed test
	Yes, pass or done
	No or fail or cancel
	Purge or pump running icon
	Select temp 1 (flow) (Differential Temperature Test)
	Select temp 2 (return) (Differential Temperature Test)
	Save log
	Export report/log to IR Printer
	Export report/log to Mobile App
	Delete
	Edit value
	Increase value
	Decrease value
	Descend through character list (String edit)
	Ascend through character list (String edit)
	CO Alarm
	Select Net/Gross/NetHE Efficiency



IR Printer Alignment

## Safety and product related information:

- Read and understand all instructions in the operation section of this manual before use.
- Observe all warnings and instructions marked on Sprint Pro, or as prompted by the analyser and within this manual.
- Sprint Pro must only be operated with the Sprint Pro Flue Probe assembly and always with the water trap and filters in place.
- Connect the Flue Probe Assembly to Sprint Pro before switching on and do not insert probe into flue until after the zeroing process is complete.
- Sprint Pro water trap must be dried after use and before Sprint Pro Flue Probe Assembly is returned to carry case.
- Sprint Pro will lock out its Test Menu once calibration has expired.
- Before use ensure Sprint Pro is in good repair and do not use if damaged or if calibration has expired.
- Sprint Pro passes the requirements of EN50379-1 and EN50379-3 and has been independently tested by BSI.
- Sprint Pro is designed for use in ambient temperatures in the range -10°C to +50°C and should not be used outside this range.
- Sprint Pro contains a re-chargeable Lithium ion battery.
- Sprint Pro's battery must not be charged at temperatures below 0°C or above 40°C.
- If Sprint Pro is damaged do not use and return to a qualified service centre for repair/replacement.
- Service, calibration & repair of Sprint Pro must only be undertaken by a qualified service centre.
- Do not substitute components as this may impair safety and invalidate warranty.
- Repair of Sprint Pro and gas sensor replacement shall be carried out by the manufacturer or qualified service centre in accordance with the applicable code of practice.
- If this product is not working properly, read the troubleshooting guide or contact the service centre.
- Batteries are non-replaceable by the user and must only be replaced by authorised service centres.
- Sprint Pro battery is rechargeable via a USB-C input connector.
- Sprint Pro must be charged via a USB charger that meets the specification as detailed in the user manual.
- Sprint Pro is not to be used as a permanent fixed detector.
- Sprint Pro is not designed or tested for continuous use.
- Sprint Pro is not a safety alarm.
- Only use probes, leads and accessories supplied by the manufacture.
- Do not subject the product to cleaning fluids, such as

those containing high concentrations of acetone and silicone compounds (such as silicone grease).

- Do not immerse in water.
- Do not use silicon grease on the O-rings.
- Fuel options available are: natural gas, LPG, heavy oil, light oil, coal, wood, wood pellet dry, coke, Biomass and Bagasse.

## Additional information:

Sprint Pro is designed to meet the requirements of EN50379-1 and EN50379-3 and to support the working practices defined in British Standard BS7967.

It is highly recommended that users are fully conversant with BS7967 when using a flue gas analyser for servicing or installing a boiler system.

When performing any CO measurements **ensure the unit is zeroed in clean air** in accordance with British Standard BS7967. A suitable location for sampling clean air will be outside of the building where the boiler system is installed, away from exhaust vents.

Sprint Pro offers a timed let-by/tightness test in accordance with the UK's Institute of Gas Engineers' procedure IGEM/11/ UP/1PB.

If the Sprint Pro has not been used for more than 6 months it should be put on charge for at least 4 hours without use. This will allow the oxygen channel and if present the NO channel, to read correctly. Failure to do this may cause the oxygen measurement, the NO measurement and any calculations depending upon them to be incorrect.

Magnets on the reverse of Sprint Pro can be used to place the Sprint Pro in location on the boiler system for easy hands-free operation.

Diagnostics and usage data from Sprint Pro is accessible at service and can be viewed at service centers. We reserve the right to update and enhance the software at times of service without prior knowledge.

**WARNING:** Take care not to place items which may be sensitive to strong magnetic fields near this magnet, e.g. credit cards or magnetic storage devices like computer hard drives.

## FCC compliance

Sprint Pro FCC number: A8TBM78ABCDEF GH

© Copyright Crowcon Detection Instruments Ltd 2019.  
All rights are reserved. No part of the document may be photocopied, reproduced, or translated to another language without the prior written consent of Crowcon Detection Instruments Ltd.

Publication number: M07723

Second edition: May 2019

## NOTE:

This product uses the FreeRTOS.org real time kernel available from <http://www.FreeRTOS.org>  
The FreeRTOS source code is licensed by the GNU General Public License (GPL) with an exception.  
The full text of the GPL is available here: <http://www.freertos.org/license.txt>.  
The text of the exception is available on FreeRTOS official website: <http://www.FreeRTOS.org> - License and Warranty Page



---

# Contents

---

Sprint Pro Multi-function Flue Gas Analyser .....	2
Unpacking .....	2
I. Sprint Pro Orientation .....	3
Overview .....	3
Probe connections .....	4
Switch on and using the Menu .....	4
Switch off .....	4
Charging battery.....	5
Pump.....	8
Keypad overview.....	8
Menu structure.....	9
II. Set Up & Menu Configuration Options.....	10
Fuel options.....	10
Units of measurement.....	10
Analyser settings.....	11
III. Performing tests.....	14
Zeroing process.....	14
1. Flue gas analysis.....	15
2. Let-by, Stabilisation and Tightness test .....	16
4. Differential temperature test .....	19
5. Room Safety test.....	20
6. Appliance sweep test.....	21
7. Gas escape test.....	22
8. Ambient air monitor (not available on Sprint Pro 1) .....	22
IV Logging .....	24
V. Test Report/Log exporting .....	25
VI. Maintenance and Calibration.....	26
VII. Sprint Pro Specification .....	28
VIII. Accessories and spare parts.....	31
Accessory list .....	31
IX. Troubleshooting guide .....	32
Appendix I: Room Safety Test.....	34
Warranty .....	38
Sprint Pro Warranty Limitations.....	39

---

# Sprint Pro

## Multi-function Flue Gas Analyser

---

Thank you for purchasing the *Sprint Pro Multi-function Flue Gas Analyser*. Sprint Pro will give you years of unparalleled service and reliability if looked after correctly.

There are six versions covered in this manual as follows:

- Sprint Pro 1 Standard model flue gas analyser with CO and O<sub>2</sub> sensor
- Sprint Pro 2 As Pro 1 with pressure and gas escape probe (GEP) capability (available as an option) and upgradability for CO<sub>2</sub> and NO measurements
- Sprint Pro 3 As Pro 2 with a GEP probe included and mobile application connectivity
- Sprint Pro 4 As Pro 3 with a CO<sub>2</sub> room measurement sensor
- Sprint Pro 5 As Pro 3 with a NO measurement sensor
- Sprint Pro 6 As Pro 3 with a NO and CO<sub>2</sub> measurement sensors

Please read the instructions carefully before use. Keep the manual for future reference.

## Unpacking

**Important: Please fully charge Sprint Pro before use.**

Remove the Sprint Pro from the packaging. The Sprint Pro accessories will be located in the carry case. Check the contents are complete, you should have:

- Sprint Pro analyser
- USB charger and USB lead
- Flue probe assembly, including water trap and filters.

# I. Sprint Pro Orientation

## Overview

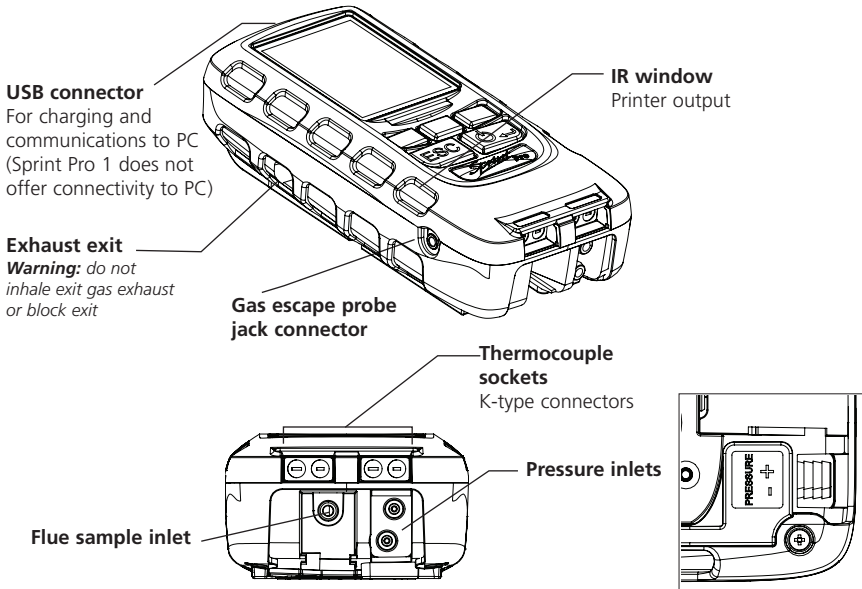
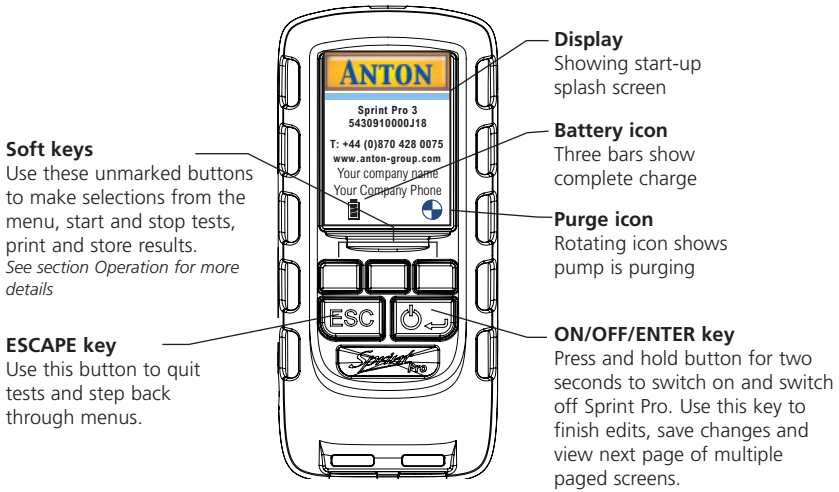

## Probe connections

### Flue gas analysis

Connect the flue probe to the flue sample inlet and the thermocouple to either K-connector.

To measure flue draught pressure connect pressure tube to (-) pressure inlet.

### Differential pressure, working pressure, operating pressure and let-by and tightness tests (not available on Sprint Pro 1).

Connect tubing to pressure inlet(s).

### Differential temperature test

Connect one (or two) thermocouple probes to the K-type connectors. When using one probe, Sprint Pro will display a soft key option to switch between T1 and T2 snapshot measuring points.

**Note:** When using (a) two thermocouples on metal pipes, or (b) any thermocouples whilst the Sprint is on charge - electrically isolated thermocouples should be used.

Alternatively, cover the thermocouple contacts with plumbers tape to electrically isolate the thermocouple contacts from the pipes.

### Gas escape test (not available on Sprint Pro 1).

Connect the gas escape probe (GEP) to the jack connector socket.

**Note:** The pump may operate or switch off depending on the test being performed.

## Switch on and using the Menu

Press and hold the ON/OFF/ENTER key for two seconds. Sprint Pro will emit a few rising beeps, display the splash screen and then enter the *Main Menu*.

Use the soft keys to scroll, select and edit menu items (see icon list – inside front cover). Press accept  to make a change or the ESC key to cancel. Press the ESC key to return to the *Main Menu*.

**Tip:** see soft key icon list on the inside front cover of this manual

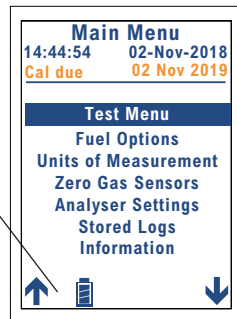

## Switch off

**Note:** Ensure flue probe is attached to Sprint Pro (including water trap and filters) prior to following the switch off procedure and allow the sensor readings to return to their ambient levels.



Turn off in clean air and allow Sprint Pro to complete purge cycle. Press and hold the ON/OFF/ENTER button for approximately two seconds. The power off screen will be displayed and the pump will run to purge the sensors. The pump will run for up to 30 or 40 seconds to purge if gas is present. Sprint Pro will normally switch off in 10 seconds. Press the ESC key to abort the switch off sequence.

## Charging battery

It is recommended that Sprint Pro is fully charged before first use.

**Note:** Sprint Pro's battery must not be charged at temperatures below 0°C or above 40 °C.

1. Plug the USB charger into a mains socket.
2. Connect the charger to the Sprint Pro using the USB-C connector on the unit.
3. Switch on the power at the mains socket.
4. Sprint Pro would normally be left switched off for charging. The display will show the battery charging icon during charging. The battery will recharge in three hours from flat and when fully charged the battery icon will turn green in colour.

Please see specification in section VII for Sprint Pro run times. A shorter charge time can be applied, such as 1/2 hour, though it will give limited length of operation from that charge.

## Low battery

When the battery is low, Sprint Pro will display a low battery icon. If the battery gets too low, then Sprint Pro will give further warning before switching off.

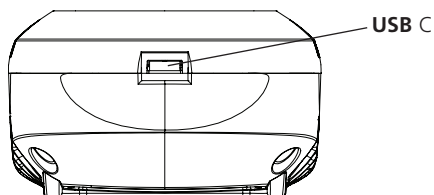

On a low battery alert, plug in the charger. If this cannot be done immediately finish the test in progress and then place on charge as soon as possible.

## Use of the charger as a power adaptor

The Sprint Pro charger can be used to power the unit and will continue to charge whilst operating Sprint Pro.

**If the battery has been allowed to become exhausted or nearly exhausted:**

When turning on the Sprint Pro, if the Time & Date have been lost, a Time & Date entry screen will be presented to allow the correct current Time & Date to be entered.

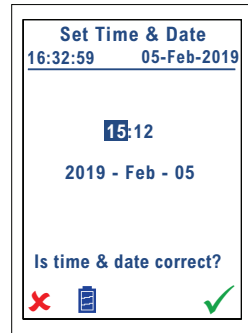
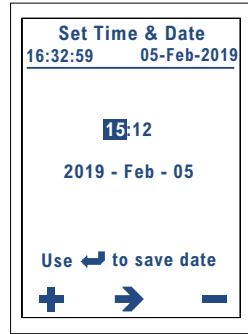

If an attempt is made to turn the instrument on when the battery level is too low for the instrument to operate, a warning screen will be displayed.

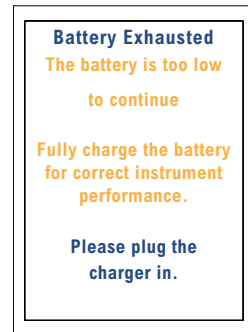

**Automatic battery saver**

If Sprint Pro is not undertaking a test it will automatically power down if left unused. Sprint Pro will warn user when power down is imminent.

If the instrument enters the auto turn-off state due to an exhausted battery, this screen will be displayed, with the red, empty, battery icon flashing:

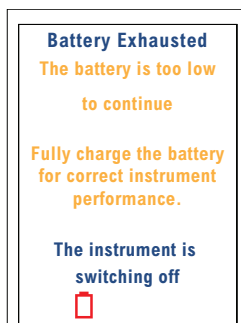

If the instrument is turned off in a low-battery alert state (battery icon red, double beep alert tune sounding) then this screen will be displayed. The title will be alternating 'Low Battery Warning' and 'Turning Off'. When the progress bar has completed (after about 8 seconds) or the Continue (middle) button is pressed, the normal purge screen will be shown with the turn off proceeding normally.

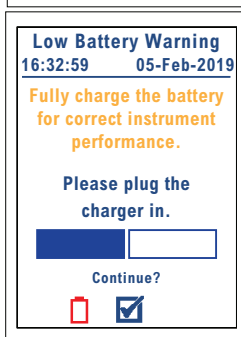

Sprint Pro has a lithium-ion rechargeable battery.

Batteries are non-replaceable by the user and must only be replaced by authorised service centres.

**Note:** Fully charging the battery before putting Sprint into storage for an extended period will help to maintain the battery's life expectancy.

**Warning:** Only use USB chargers provided with Sprint Pro and standard USB-C charger leads.

## O2 Sensor Warning

If Sprint Pro battery becomes extremely exhausted, when Sprint Pro is subsequently charged and turned on the O2 sensor will require an extended stabilisation time. The instrument will indicate this on the display, it is important that the charger remain connected for the duration of the stabilisation time until the display reports 'Sensor ready'.

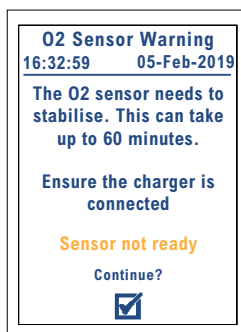

Once the sensor is ready for use, pressing the 'Continue' (middle) button will acknowledge this warning and allow normal instrument function.

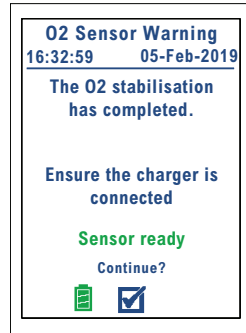

## Pump

Sprint Pro runs the internal pump during purge and when certain tests are selected, and during and after some tests. A rotating purge icon will appear on the screen when purging. To save on the battery life, Sprint Pro will turn off the pump when it is not required.

When the pump is running ensure the exit gas exhaust is not blocked and do not breathe in the exhaust gases. The purge function is often used by Sprint Pro to put clean air over the sensors prior to turning off. This is ideal for realising the full potential lifespan of the sensors, especially the CO sensor filters.

## Keypad overview

Sprint Pro provides a large colour LCD with backlight. Navigation and functions are provided by three soft key buttons which change according to what you are doing.

Use the soft keys to navigate menus, select, start and end tests, change options and select actions; such as print, log or zeroing.

Use the ESC key to exit menus, exit tests and step back through screens.

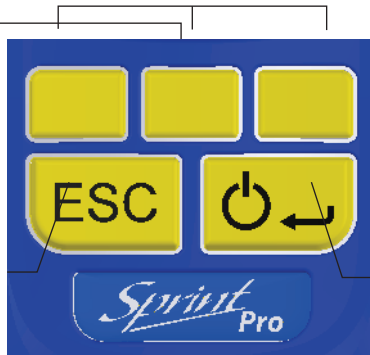

ON/OFF/ENTER switch. Use this key to finish edits, save changes and view next page of multiple paged screens.

## Menu structure

After your Sprint Pro has been switched on the display will show the *Main Menu* screen ready for use.

To select a menu item, use the soft keys below the **↑** and **↓** screen icons to scroll the menu list and press the soft key underneath the **☑** screen icon to select. Some menus also have their own submenu.

Press the ESC key to exit a menu, press ESC twice to return to the *Main Menu* from a submenu.

The soft keys control the function displayed above them on the screen. These will change depending on the test or menu, or if the ESC key is pressed.

To display Sprint Pro serial number, identity and software version press the ESC key from the *Main Menu*.

The menu structure is shown below:

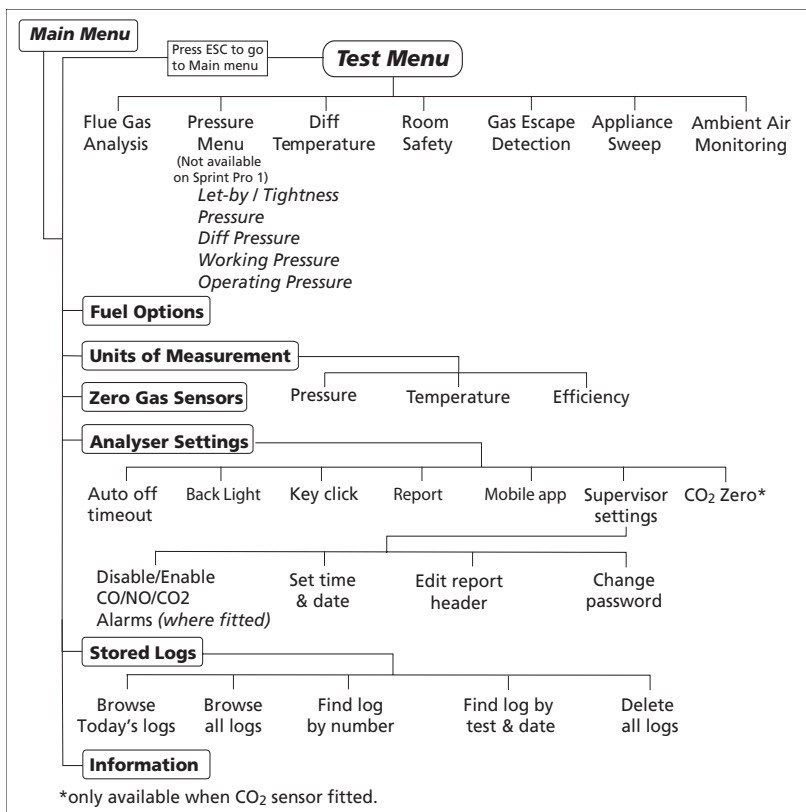

---

## II. Set Up & Menu Configuration Options

---

This section of the manual describes how to change the default configured options if required, if not required please refer to Section III for details on Performing Tests.

### Fuel options

Sprint Pro displays the current fuel option during flue gas testing on the *Flue Gas Analysis* screen.

To change the fuel option required, from the *Main Menu* select *Fuel Options*.

Use the soft keys  $\uparrow$  and  $\downarrow$  to navigate the available fuels and select the required fuel using the  $\checkmark$  soft key.

The new fuel option will be displayed on the *Flue Gas Analysis* screen during testing.

Fuel options available are: Natural gas, LPG, Heavy oil, Light oil, Coal, Wood, Wood pellet dry, Coke, BioMass and Bagasse.

**Notes:** NetHE only available for fuels natural gas, LPG, light oil and heavy oil.

When performing tests on oil fueled appliances, please use C03767/S the Oil Burner Kit (sold separately)

### Units of measurement

To change the units of pressure, temperature or efficiency from the *Main Menu* select *Units of Measurement*.

Use the soft keys  $\uparrow$  and  $\downarrow$  to navigate the available submenus and units and select the required option using the  $\checkmark$  soft key.

Select one of the following options.

Temperature: degrees Celsius ( $^{\circ}\text{C}$ ) or degrees Fahrenheit ( $^{\circ}\text{F}$ ).

Pressure: mBar, Pa, hPa, kPa, PSI, inWG, mmWG, inHG and mmHG. % Efficiency: Net or Gross.

**Note:** During flue gas analysis for High Efficiency/Condensing boilers Sprint Pro will switch automatically to NetHE (Net High Efficiency) if Net Efficiency is selected.

The formulae and constants used for Gross and Net efficiency calculations are those specified in EN50379. In general it is Net efficiency which is normally quoted. For modern condensing boilers the Net efficiency calculated may exceed 100%.

## Analyser settings

The Analyser settings menu allows you to alter the settings for the display, auto off timeout, back light, key pad and Supervisor settings. To change any of these settings from the *Main Menu* select *Analyser Settings*. Use the soft keys **↑** and **↓** to navigate the available submenus select the required option using the **✓** soft key.

### Auto off timeout

The *Auto off timeout* screen allows the number of minutes at which the Sprint Pro will automatically switch off to be selected. Use the soft keys **-** and **+** to reduce or increase the number of minutes. Press the **✓** key to accept the change or ESC to cancel. To disable *Auto off timeout* press **-** key until 'disabled' is displayed.

### Backlight

Use the soft keys **↑** and **↓** to select one of the following options: *Dim*, *Mid* or *Bright*.

### Key click

The Key click settings allows the audible 'clicks' when the keypad is pressed to be enabled or disabled.

Use the soft keys to select *Enabled* or *Disabled* from options. Press the **✓** key to accept the change or ESC to cancel.

### Report

The report option allows the selection of the means by which the logs and test reports will be exported.

Use the soft keys **↑** and **↓** to select between the following options and the **✓** key to accept

*IR Printer*: Logs and test reports will be exported to IR printer (Sprinter).

*Mobile App*: Logs and test reports will be exported to mobile app.

*Select by key hold*: Allows soft key to be held which will toggle between IR printer and Mobile App.

### Mobile app

Allows turning on or off mobile app functionality.

*Off:* Permanently off



*On:* Permanently on

*On by report option:* Switched on or off as required by selection in Report configuration.

**Note:** Report and Mobile app options have an interaction between them, the last option selected will be implemented and the corresponding option may be modified to maintain consistency. Sprint Pro will provide a message indicating a change has been made.

### Supervisor settings







#### CO/NO/CO2 Alarm



Gas alarms for CO / NO /CO2 can be enabled or disabled (options will be present depending on model). Use the soft keys  and  to change the setting.

#### Set time & date





On the *Time & Date* screen the current time and date are shown. Use the soft keys – and + to alter the values of hours, minutes, day, month and year. Use the  key to select each unit. Press the ESC key to accept the change.

#### Edit report header

Use the soft keys  and  to select the report header text line one or two. Press  key to edit text. The screen displays the character lists and highlights the current list in use. Use the  and  keys to scroll through character values in each list and  to move on to the next letter in the header text. The character lists are shown below.

Press ON/OFF/ENTER to delete characters to the right. Press  to move the cursor to the end of the text and  to accept change and return to *Edit report header* screen.

#### Change password

Press the soft key  to edit password. Use the  and  keys to edit or create a password as described above in Edit report header. Press  to accept change and return to *Password* screen. Press ON/OFF/ENTER to store the change.

When a password has been created, Sprint Pro will display the *Supervisor password* screen on entering *Supervisor settings*.

See table of settings.

! .. /	!"#\$%&'()*+,-_ /	A .. Z	Uppercase alphabet
0 .. 9	0123456789	a .. z	Lowercase alphabet
: .. @	::<=>?@	Space	



**Tip:** It is a good idea to enter your name/company name and phone number to identify Sprint Pro and then set a password to prevent others changing these settings.

## **CO<sub>2</sub> Zero**

In normal operation Sprint Pro will perform its zeroing function whilst in clean air.

However if it is not possible to undertake the zeroing function in clean air then a CO<sub>2</sub> scrubber can be utilized.

*In clean air:* Sprint Pro will undertake the zeroing function in clean air and a CO<sub>2</sub> scrubber must not be used whilst zeroing.

*With scrubber:* Sprint Pro will undertake the zeroing function in clean air and a CO<sub>2</sub> scrubber must be used whilst zeroing.

---

## III. Performing tests

---

### Important:

**Sprint Pro must only be used with the Sprint Pro flue probe assembly and always with the water trap and filters in place.**

**Please ensure the flue probe is connected before switching on your Sprint Pro unit. Ensure the water trap is empty and is fitted in the right direction. Always start in clean air and ensure that the gas exhaust is not blocked. Do not insert the probe into the flue until after the zeroing process is complete.**

**Notes:** Sprint Pro will switch off the pump when not performing tests or purging. When performing tests on oil fueled appliances, please use C03767/S the Oil Burner Kit (sold separately)

### Zeroing process

Following Switch on Sprint Pro will require a 'zero' before selection of any of the following tests: *Flue Gas Analysis*, *Room Safety* test, *Appliance Sweep* test or *Ambient Air Monitor* test.

**Ensure you are in clean air before proceeding with the zeroing process.**

The zeroing process will then not be required when selecting these menu options unless Sprint Pro is subsequently switched off and on.

Press the  key to confirm you are in clean air. The Sprint Pro will then perform a 'zero'. Provided the zeroing process is successful Sprint Pro will display the menu option chosen.

**Tip:** To ensure the zero is performed in clean air undertake the zeroing process outside of the building or well away from the heating appliance to avoid any potential gases in the vicinity affecting the zero process.

This is especially important for Sprint Pro 4 and Sprint Pro 6 because of the additional carbon dioxide sensor.

If a CO<sub>2</sub> sensor is fitted and it is not possible to undertake the zeroing process in clean air a CO<sub>2</sub> scrubber can be utilised, please see *Analyser Settings* section.

**Warning:** During testing, ensure the combined filter and water trap is not blocked or full. Failure to do so may result in an error message.

# 1. Flue gas analysis

Before performing the flue gas analysis test, check the water trap is clean and is upright (arrow should point in direction of gas flow). To begin test, select *Flue Gas Analysis* from the *Test Menu*. If the zeroing process has not previously been performed Sprint Pro will carry out a 'zero' and then enter the test screen. Check the fuel type displayed on the screen is correct. Use the soft keys to log or print results.

Press the ON/OFF/ENTER button to display the screens available:

Screen 1: O<sub>2</sub>, CO, CO<sub>2</sub>, CO/CO<sub>2</sub> ratio, Pressure.  
(Not available on Sprint Pro 1)

Screen 2: O<sub>2</sub>, excess (XS) air, Temperature Flue and Efficiency.

Screen 3: combines flue elements from previous screens.

Screen 4: (if NO sensor not fitted): Temperature Flue, Temperature Inlet, Net Temperature

Screen 4: (if NO sensor fitted): NO, NO<sub>x</sub>, CO, CO<sub>2</sub>, Ratio, O<sub>2</sub>

Screen 5: (if NO sensor fitted): Temperature Flue, Temperature Inlet, Net Temperature

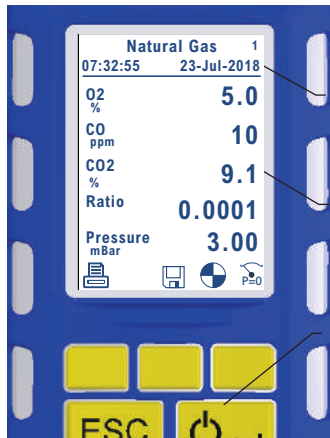

**Tip:** The screen number is displayed here.

**Tip:** If # symbol is displayed - flue probe is not in flue or not connected.

**Tip:** Press the ON/OFF/ENTER button to cycle through the screens.

Natural Gas 1	
07:32:55	23-Jul-2018
O <sub>2</sub> %	5.0
CO ppm	10
CO <sub>2</sub> %	9.1
Ratio	0.0001
Pressure mBar	3.00

Screen 1

Flue Gas Analysis 2	
07:32:55	23-Jul-2018
O <sub>2</sub> %	5.0
XS air %	31.4
Temp flue C	158
Efficiency %Net	94.2

Screen 2

Flue Gas Analysis 3	
07:32:55	23-Jul-2018
O <sub>2</sub> %	5.0
CO ppm	10
CO <sub>2</sub> %	9.1
Ratio	0.0001
XS air %	31.4
Temp. flue c	162
Effcy %Net	94.0
Press. mBar	3.00

Screen 3

Flue Gas Analysis... 4	
07:32:55 23-Jul-2018	
NO ppm	NO mg/m <sup>3</sup>
20	21
NOx ppm	NOx mg/m <sup>3</sup>
21	22
CO ppm	CO <sub>2</sub> %
10	9.1
Ratio	O <sub>2</sub> %
0.0001	5.0

Screen 4

Flue Gas Analysis... 5	
07:32:55 23-Jul-2018	
Temp. flue C	55
Temp. inlet C	24
Net Temp C	31

Screen 5

To perform a pressure zero (not available on Sprint Pro 1), use the soft key marked  on the relevant screen.

To scroll through the efficiency options, use the soft key marked .

**Note:** for personal safety a carbon monoxide (CO) alarm will activate at 350ppm. This will deactivate when CO levels drop below 200ppm. This is to inform the user of potentially hazardous exhaust levels.

To end test press the ESC key.

**Note:** The minimum test duration should exceed both the time taken for burners to heat up, during which the CO and NO produced may not be representative of subsequent operation, and also the time needed for the boiler output to stabilise. Both these periods are less than 5 minutes for most boilers hence flue test duration should be a minimum of 5 minutes and a maximum of 30 minutes.

**Values** of Oxygen (O<sub>2</sub>), carbon monoxide (CO), nitric oxide (NO), pressure, inlet temperature and flue temperature are measured and displayed by Sprint Pro.

**Values** of carbon dioxide (CO<sub>2</sub>), carbon monoxide to carbon dioxide ratio, excess air (XS Air), efficiency, NOx and net temperature are calculated and displayed by Sprint Pro.





**Note:** When using Sprint pro with oil or solid fuel boilers, to ensure correct operation and prolong the life of the filters, testing guidance in CD/11 (Oil Firing, Servicing and Commissioning standard) should be followed.

CD/11 recommends undertaking initial tests to check cleanliness of combustion prior to flue gas analysis testing. Thus please light the burner and allow it to run for at least ten minutes to establish settled conditions. At this time take a smoke spot reading at the test point provided. Adjust until a satisfactory figure is obtained.

Now it is possible to carry out a flue gas analysis test.

## 2. Let-by, Stabilisation and Tightness test

Before carrying out the test, the pressure must be zeroed with the tube connected to Sprint Pro but not the pressure source. Note: in these tests 'Diff press' is the difference between start and finish pressures.

1. Select *Pressure Menu* from the *Test Menu*. From the *Pressure Menu* select *Let-by / Tightness*.
2. Connect tube to positive pressure inlet on Sprint Pro.
3. Zero pressure, use the soft key marked .
4. Connect tube to pressure source and ensure correct starting pressure.
5. Press the soft key  to start test. Sprint Pro displays the duration time on the screen.
6. To stop test press the soft key .
7. To pass *Let-by* test, press the soft key  to proceed to *Stabilisation* and *Tightness* tests.

To fail the *Let-by* test press the key . Use the soft keys to log or print the results as required.

To carry out the *Let-by* test again press  and restart from step 2.

Let-by	
14:47:55	13-Oct-2018
Start P1	!>
mBar	
Finish P2	0.00
mBar	
Diff press	0.00
mBar	
Duration	00:00



Screen 1

Let-by	
14:47:55	13-Oct-2018
Start P1	!>
mBar	
Finish P2	0.00
mBar	
Diff press	0.00
mBar	
Duration	00:25

Screen 2

Let-by	
14:47:55	13-Oct-2018
Start P1	!>
mBar	
Finish P2	0.00
mBar	
Diff press	0.00
mBar	
Duration	00:54

Screen 3

8. Press the soft key  to start *Stabilisation*. Sprint Pro displays the duration time on the screen.
9. To stop test press the soft key .
10. Press the soft key  to pass the *Stabilisation* test and proceed to *Tightness* test.

To fail the *Stabilisation* test press the key .

Use the soft keys to log or print the results as required.

To carry out the *Stabilisation* test again press  and restart from step 8.

Stabilisation	
14:47:55	13-Oct-2018
Start P3	-0.10
mBar	
Finish P4	-0.10
mBar	
Diff press	0.00
mBar	
Duration	00:25

11. Press the soft key ► to start *Tightness* test. Sprint Pro displays the duration time on the screen.
12. To stop *Tightness* test press the soft key ■.
13. Press the soft key ✓ to pass test.  
To fail the *Tightness* test press the key ✕.  
If required the use the soft keys to log or print the results.

To carry out the *Tightness* test again press ⏪ and restart from step 11.

At the end of the *Tightness* test use the soft keys to log or print the results as required.

Press the ESC key to return to the *Pressure Menu*. Press ESC again to return to *Test Menu*.

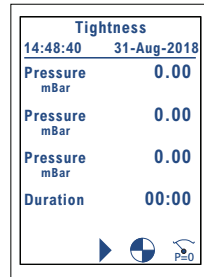

### 3. Pressure, Differential Pressure, Working Pressure and Operating Pressure tests (not available on Pro 1)

Before carrying out the test the pressure must be zeroed with the tubes connected to Sprint Pro but not to the pressure source. A thermocouple may be connected to provide temperature readings in these tests.

1. Select *Pressure Menu* from the *Test Menu*. From the *Pressure Menu* screen options select *Pressure*, *Differential Pressure*, *Working Pressure* or *Operating Pressure*.
2. Connect tube to pressure inlet on Sprint Pro.
3. Zero pressure, using the soft key marked .
4. Connect tube to pressure source and ensure correct starting procedure.
5. There is an option to time this test, Sprint Pro displays the duration time on the screen.  
Press the soft key ► to start test and timer.
6. To stop timed test press the soft key ■.

**Tip:** plug in the Thermocouple probe to view temperature on screen.



**Tip:** optional timer

- To restart test press the soft key .

To re-zero Sprint Pro, press .

Press the ESC key to return to the *Pressure Menu* screen. To perform the other pressure tests repeat steps 2 to 7 above.

At the end of the test for *Working Pressure* and *Operating Pressure*, use the soft keys to log or print the results as required.

## 4. Differential temperature test

Sprint Pro can perform a differential temperature test with one or two thermocouple probes. To begin test, select *Differential Temperature* from the *Test Menu*. Check the units displayed are as required, if not units can be changed in the *Units of Measurement* menu. If no probes are connected Sprint Pro will display ####.

**If connecting to metal surfaces, use electrically isolating clamps/probes, or isolate the temperature probe contacts with Plumber's Tape.**

### Two probe test

Connect both probes to the K-type connectors on the Sprint Pro. Place probes in position. The screen will display the temperature of probe 1 and probe 2, and the differential temperature.

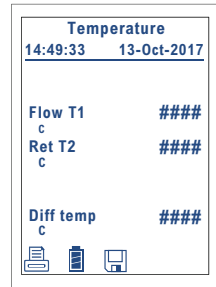



Use the soft keys to log or print the results as required.

To end test press the ESC key.

### Single probe test

When only a single probe is available, Sprint Pro will display an additional icon on the screen to allow the first and second reading to be taken separately.

- Place probe in position 1 to make measurement T1.
- Press the soft key icon  to take a snapshot reading of T1. (Do not remove probe until this snapshot is taken.)
- Move the probe into position 2 to take second reading T2. The screen will display the icon  to show temperature reading T2 is being taken. The screen will display the snapshot temperature, the live probe temperature, and the differential temperature.

Use the soft keys to log or print the results as required.

To end test press the ESC key.

## 5. Room Safety test

**Note:** CO<sub>2</sub> readings detailed in this section will only be displayed where a CO<sub>2</sub> sensor is fitted. For further details on performing Room CO Safety Tests, see Appendix I.

1. Select *Room Safety* from the *Test Menu*.
2. If a 'zero' has been performed since switch on, Sprint Pro will display the *Room Safety Menu*.

If a 'zero' has not been performed since switch on, Sprint Pro will initiate the zeroing process. Press the  key to confirm you are in clean air and if successful Sprint Pro will then display the *Room Safety Menu*.

3. Select the appropriate appliance from the list.

If required connect probe to the Sprint Pro and place at the recommended height.

**Note:** Refer to British Standard BS7967 if necessary.



The pump will switch on in readiness for test.







**Note:** The sound of the pump operating does not indicate the test has begun.

4. Press the  soft key to start test.

During the test the screen will display the CO & CO<sub>2</sub> readings, peak CO & CO<sub>2</sub> readings, duration of the test and allowable test parameters.

The test will run for the required duration by appliance according to BS7967. Sprint Pro will emit an alarm if 30ppm (or 90ppm) threshold is exceeded for the CO test or 0.28% (or 0.5%Vol) for the CO<sub>2</sub> test. Sprint Pro is programmed with pass/fail criteria for this test. Refer to British Standard BS7967 for further details on performing room CO safety tests.

When the minimum duration is met (as defined by BS 7967:2015) the ON/OFF/ENTER key can then be used to cycle through the CO & CO<sub>2</sub> *Room Safety* screens and the  soft key will end the test. Use the soft keys  to continue or  to select 'Quit test?' Use the soft keys to log or print the results as required.

<p><b>Room Safety..</b> <sup>1</sup> 07:32:55 23-Jul-2018</p> <p>CO ppm <b>2</b></p> <p>Peak CO ppm <b>2</b></p> <p>Duration &gt;allowed <b>00:00</b></p> <p>Duration of test <b>04:43</b></p> 	<p><b>Boiler (open flue)</b> <sup>2</sup> 07:32:55 23-Jul-2018</p> <p>CO ppm <b>2</b></p> <p>Peak CO ppm <b>2</b></p> <p>CO2 ppm <b>500</b></p> <p>Peak CO2 ppm <b>600</b></p>  	<p><b>Boiler (open flue)</b> <sup>3</sup> 07:32:55 23-Jul-2018</p> <p><b>Test Parameters</b></p> <p>Allowed CO ppm <b>10</b></p> <p>Maximum Time&gt;allowed <b>01:00</b></p> <p>Test time Minimum <b>15:00</b></p> <p>Test time Maximum <b>30:00</b></p> 	<p><b>Boiler (open flue)</b> <sup>4</sup> 07:32:55 23-Jul-2018</p> <table border="1"> <thead> <tr> <th>Mins.</th> <th>COppm</th> <th>CO2ppm</th> </tr> </thead> <tbody> <tr><td>1</td><td>2</td><td>600</td></tr> <tr><td>2</td><td>1</td><td>500</td></tr> <tr><td>3</td><td>2</td><td>500</td></tr> <tr><td>4</td><td>2</td><td>500</td></tr> <tr><td>5</td><td>2</td><td>500</td></tr> <tr><td>6</td><td>2</td><td>500</td></tr> </tbody> </table> <p>Duration of test <b>05:00</b></p>  	Mins.	COppm	CO2ppm	1	2	600	2	1	500	3	2	500	4	2	500	5	2	500	6	2	500
Mins.	COppm	CO2ppm																						
1	2	600																						
2	1	500																						
3	2	500																						
4	2	500																						
5	2	500																						
6	2	500																						



The ON/OFF/ENTER key can then be used to cycle through the various *Room Safety* screens.

To stop the test before the minimum duration is met, press the ESC key and use the soft keys ✓ or ✗ to select 'Quit test?'

**Note:** If an in-line NO filter is fitted please allow the room test to carry on in excess of 10 minutes in order to get a true CO<sub>2</sub> reading.

## 6. Appliance sweep test

**Warning:** The CO and CO<sub>2</sub> alarms should be enabled before beginning appliance sweep tests. It is possible to enable these alarms using the supervisor menu.

**Note:** CO<sub>2</sub> readings detailed in this section will only be displayed where a CO<sub>2</sub> sensor is fitted.

The appliance sweep test should be carried out in conformance to BS 7967:2015.

1. Select *Appliance Sweep Test* from the *Test Menu*.
2. If a 'zero' has been performed since switch on, the pump will switch on in readiness for test.

If a 'zero' has not been performed since switch on, Sprint Pro will initiate the zeroing process. Press the  key to confirm you are in clean air and if successful the pump will switch on in readiness for test.

**Note:** The sound of the pump operating does not indicate the test has begun.

3. Connect probe to the Sprint Pro.  
**Note:** Refer to British Standard BS7967 if necessary.
4. Press the ► soft key to start test. During the test the screen will display the CO & CO<sub>2</sub> readings, peak CO & CO<sub>2</sub> readings, duration of the test and allowable test parameters, time period has elapsed Sprint Pro will give an audible indication and the ■ soft key can be pressed to stop the test

5. Use the soft keys to log or print results as required.

Appliance Sweep Test	
15:37:55	31-Aug-018
CO ppm	10
Peak CO ppm	###
Allowed CO ppm	10
CO <sub>2</sub> %	0.00
Duration of test	00:00
	► ◀

The test will run for the required duration where each sweep must last at least 2 minutes. Max allowed CO is 10ppm; if this level is exceeded the test fails.

To stop test at any time, press the ESC key. Use the soft keys ✓ or ✗ to select 'Quit test?'

## 7. Gas escape test

**Note:** Battery power will be used at a higher rate under this test.

Select *Gas Escape Detection* from the *Test Menu*. Connect the gas escape probe (GEP) to the GEP jack connector, the light will illuminate on the probe. Sprint Pro will display a warning if the probe is not connected.

Sprint Pro will display 'Checking Sensor' then 'Sensor Settling' for approximately 30 seconds. When the sensor is stable Sprint Pro will ask 'in clean air?' before zeroing. Press  to zero. Sprint Pro will display a bar graph on the screen as gas levels are monitored.

Place the probe in the area of inspection for several seconds before moving it to other locations. Sprint Pro will emit continuous clicks like a Geiger counter. If higher gas levels are detected the bar graph will increase in readings and the sounder will increase in pitch.

Press ESC to quit the test.

As with many types of instrumentation the GEP may be damaged by impact. If the probe is dropped or suffers significant impact in another way check its operation by first plugging it into the Sprint Pro and confirming that it is recognised by the analyser.

If the Sprint Pro detects a fault with the GEP it will display a warning advising that the GEP is faulty and the test will be aborted.

If the GEP was subjected to a large impact, does not pass the described test above or is physically damaged please return to a qualified service centre for repair/replacement.

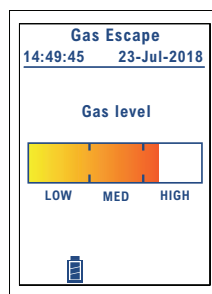

## 8. Ambient air monitor (not available on Sprint Pro 1)





**Note:** CO<sub>2</sub> readings detailed in this section will only be displayed where a CO<sub>2</sub> sensor is fitted.

1. Select *Ambient Air Monitor* from the *Test Menu*.
2. If a 'zero' has been performed since switch on, the pump will switch on in readiness for test.

If a 'zero' has not been performed since switch on, Sprint Pro will initiate the zeroing process. Press the  key to confirm you are in clean air and if successful the pump will switch on in readiness for test.



**Note:** The sound of the pump operating does not indicate the test has begun.

3. Connect probe to the Sprint Pro.

4. Use the soft keys  and  to select duration required, the interval for sampling will be displayed on the screen. The duration can be adjusted with the soft keys, from a minimum of 15 minutes (sampling every minute) to a maximum of 7 days (sampling every 30 minutes).  
Every sample consists of the peak and average over the sample period.
5. Press  to proceed with the test.
6. Then press soft key  to confirm Sprint Pro has sufficient battery life.

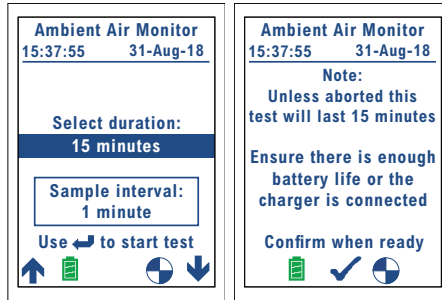



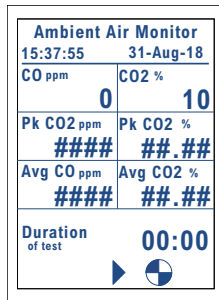

**Note:** Ensure the Sprint Pro has sufficient battery life for the duration of the test or connect the charger.



7. Press the  soft key to start test. During the test the overall peak and average gas readings for the total time of the test will be displayed.
8. To stop test at any time, press the ESC key. Use the soft keys  or  to select 'Quit test?'.
9. Use the soft keys to log or print results as required.



10. For long duration tests the number of samples may be large. It is possible to reduce the length of the exported results by only exporting samples when the peak exceeds selected levels within a given sample period.

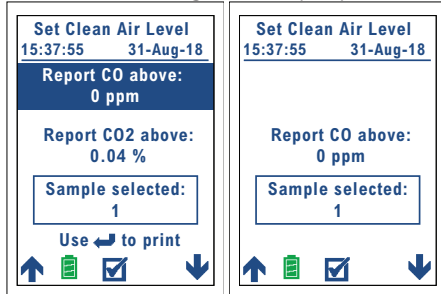

11. Using the soft keys  and  to Select Report CO above or Report CO<sub>2</sub> above, then press the soft key .
12. Use the soft keys  and  to select the gas level required and then press the soft key .
13. Press  to print report.



---

## IV Logging

---

Sprint Pro provides the option to log the results of tests. When a test is complete, use the soft key  to log the results. The display will show the *Create log* screen detailing the log number, log title, date and time. Press the accept key  to 'Store log?'. The log details recorded are then displayed on the screen. Press the  key to continue or the soft keys to print or delete the log.

### Retrieving Stored logs

From the *Main Menu* select *Stored logs* and one of the following options:

*Browse today's logs*: use the soft keys to scroll and select log from today's logs.

*Browse all logs*: use the soft keys to scroll and select log from all stored logs.

*Find log by number*: use the soft keys to select log number to retrieve specific log number.

*Find log by test type & date*: use the soft keys to select log.



### Deleting logs

**Single logs** can be deleted either via the *Stored logs Menu* or directly after a log has been recorded when the log is displayed on the screen.

From *Main Menu* select *Stored logs* and one of the following options:

*Browse today's logs*, *Browse all logs*, *Find log by number* and *Find log by type & date*.

Delete the log using the  soft icon.

**All logs** can be deleted from the *Stored logs Menu*. Scroll and select *Delete all logs* and press the  soft key. Press the yes  key 'Are you sure?' to delete all logs or press ESC to cancel. Deleting all logs resets next log number to one.

---

## V. Test Report/Log exporting

---

Logs can be printed instantly from the *Stored logs Menu*, directly after a log has been recorded and the log is displayed on the screen.

Test reports can be printed directly after a test has been completed.

### Exporting via IR printer (Sprinter)

Ensure your selected printer is switched on with paper roll installed and ready for use.

Ensure that the IR window on Sprint Pro is aligned with the IR window on the printer. The printer may be up to 1m away from the Sprint Pro.

Once required log or test report has been selected, press the Print soft key to send the file to the printer.

### Exporting via mobile app

Data can be transferred from Sprint Pro to a mobile app, Sprint Pro supports use with IOS and Android.

To transfer data to a mobile app from the *Main Menu* select *Analyser Settings* then select *Reports* and ensure 'Mobile App' or 'Select by key hold' is selected.

Once required log or test report has been selected Press the Print soft key  to send the file to a mobile app.

# VI. Maintenance and Calibration

## General

To keep the display panel and operator buttons free from dirt build-up, regularly wipe over your Sprint Pro with a slightly damp cloth.

## 4.1 Unit

Sprint Pro should be calibrated once a year and will warn you when the calibration due date is **drawing near**. If the calibration due date has passed, Sprint Pro will display a message '**Calibration overdue**'.

## 4.2 Filter and Water Trap

The combined filter and water trap is used in-line between the flue probe and the Sprint Pro main unit. It is best practice to not let any water build up inside the filter bowl, the water trap must be dried after use. A quick visual inspection before any test is advised.

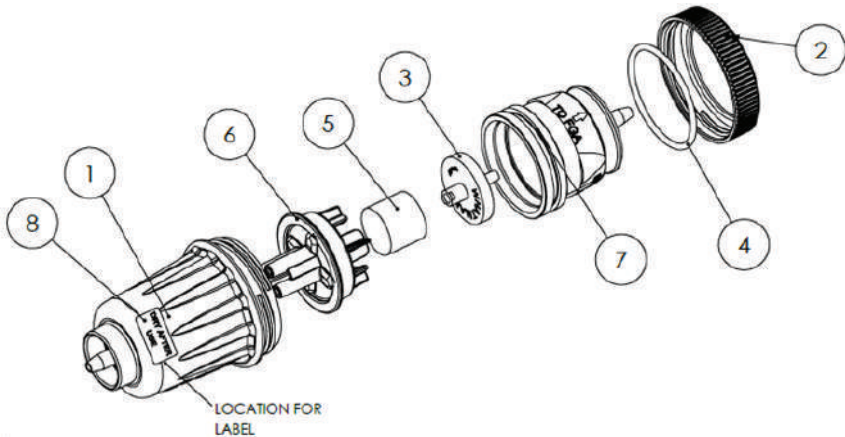

1	Bottom moulding	5	Dust filter
2	Nut moulding	6	Middle moulding
3	Water filter	7	Top moulding
4	O-ring	8	Water trap label

The water trap must be dried before use and before returning to the carry case after use.

If the filter becomes blocked clean it or replace it.

**Note:** Where a CO<sub>2</sub> sensor is fitted as carbon dioxide is slightly soluble, a lot of water present in the water trap may lead to inaccurate *Room Safety* test readings. There are no such concerns with flue gas measurements as Sprint Pro measures oxygen, which is insoluble, and calculates carbon dioxide in flue gas instead of measuring carbon dioxide directly. This means the solubility of carbon dioxide does not lead to errors in flue gas measurements.

**Warning:**

Water trap and filters must be used at all times.

**Replacing/Cleaning the dust filter:**

The dust filter element should be changed if the filter has become contaminated, dirty or if the Sprint Pro pump stalls indicating a blockage. If the filter has become soaked with water, remove from trap and squeeze the water out before reusing or replacing.

**Replacing/Cleaning the water filter**

The water filter element should be changed if the filter has become contaminated, dirty or if the Sprint Pro pump stalls indicating a blockage. If the filter has become soaked with water, remove from trap and blow the water. If the filter has become saturated it may be necessary to fully dry before reuse. If the filter is very contaminated it may be necessary to replace the filter.

After cleaning moisture out or after any filter changes, make sure the O-ring and middle disc are re-fitted in the correct position (as shown above) and the locating lugs are carefully aligned before twisting to close the water trap. Check the fastening ring of the water trap has been closed such that air cannot leak in to the water trap.

## VII. Sprint Pro Specification

### Sprint Pro

Operating Temperature Range	-10°C to +50°C
Storage Temperature Range	-20°C to +50°C.
Battery	Re-chargeable Lithium Ion.
Recharge time	~ 3 hours from flat
Operating time	CO & O <sub>2</sub> Sensors Fitted <ul style="list-style-type: none"> <li>• ~ 14<sup>h</sup> hours without pump running*</li> <li>• &gt; 5 hours pump running continuously*</li> </ul> CO, O <sub>2</sub> , NO & CO <sub>2</sub> Sensors Fitted <ul style="list-style-type: none"> <li>• ~ 8 hours without pump running*</li> <li>• &gt; 4 hours pump running continuously*</li> </ul> *No gas escape probe connected
Weight	490 g
Dimensions	85 x 50 x 183 mm (excluding probe)
Function buttons/keypad	5 button keypad
Display	Colour LCD display with backlight
Pump	Internal pump with flow fail indication.
Enclosure	Ruggedized protective Integral magnets Indoor use IP40
Standards	BSI tested to EN50379-1:2012 & EN50379-3:2012 Suitable for engineers working with BS7967:2015
Data Logging Reports	~ 400 reports (dependant on type)
Standard fuels	Natural gas (methane), LPG, Heavy oil, Light oil, Coal, Wood, Wood pellet, Coke, Biomass and Bagasse.

### Flue Probe

Insertion length	250 mm with adjustable depth gauge.
Construction	Ergonomic pistol grip with stainless steel shaft, in-built with thermocouple, in line water trap with water block filter & dust filter, bespoke connector with secondary in-built water block filter.
Overall Hose Length	2164 mm

### Gas Escape Sensor probe

Gas escape sensor	Sensor Range: 0-5,000ppm (natural gas). Integrated inspection light.
Overall Length	1960 mm



## Measurements

### Flue gas analysis

Gas	Range	Display Resolution	Accuracy	Response time (t90)
Oxygen	0-21%	0.1%	±0.3%	< 30 sec
Carbon Monoxide	0 - 200ppm 200 - 2,000ppm 2,000 - 5,000ppm	1ppm	± 10ppm or 10%rel ± 20ppm or 5%rel. ± 100ppm or 10%rel	< 45 sec
Carbon Dioxide (calculated)	0-21%	0.1%	±0.3%	< 30 sec
CO/CO <sub>2</sub> ratio	0 to 0.9999	0.0001		-
NO (where fitted)	0 - 200ppm	1ppm	± 5ppm or 1.5%rel	< 45 sec
NOx Calculated (where NO is fitted)	0 - 210ppm	1ppm	± 5ppm or 1.5%rel	< 45 sec
Flue Temperature Measurement	5°C to 400°C	1°C	±2°C or 1.5% of reading	
XS Air	0-100%			
Efficiency	0-100% Net or Gross selectable 0-120% Net High Efficiency automatic switch from Net only			

### Room Safety Test

Gas	Range	Display Resolution	Accuracy	Response time (t90)
CO	0 - 200ppm 200 - 2,000ppm 2,000 - 5,000ppm	1ppm	± 10ppm or 10%rel. ± 20ppm or 5%rel. ± 100ppm or 10%rel.	< 45 sec [45 sec]
CO <sub>2</sub> *	0% to 1.0% Vol	0.01%	± 10% of reading or ±5% of range (whichever is greater) @ 20°C+	< 60 sec

\*Where sensor fitted

+Accuracy quoted for range 0 to 0.5%Vol, warm up time to specification < 30 minutes, as at atmospheric conditions at time of calibration.

### Ambient Air Monitoring

Gas	Range	Display Resolution	Accuracy	Response time (t90)
CO	0 - 200ppm 200 - 2,000ppm 2,000 - 5,000ppm	1ppm	± 10ppm or 10%rel. ± 20ppm or 5%rel. ± 100ppm or 10%rel.	< 45 sec [45 sec]
CO <sub>2</sub> *	0% to 1.0% Vol	0.01%	± 10% of reading or ±5% of range (whichever is greater) @ 20°C+	< 60 sec

\*Where sensor fitted

+Accuracy quoted for range 0 to 0.5%Vol, warm up time to specification < 30 minutes, as at atmospheric conditions at time of calibration.

## Pressure Measurements

Measurement	<ul style="list-style-type: none"> <li>• Draught Pressure</li> <li>• Differential pressure</li> <li>• Operating pressure</li> <li>• Working pressure</li> <li>• Let-by/Tightness Test</li> </ul> Test and report/print structure for combined test suitable for use to ISEM/11/UP/1B.
Differential Range	0 – 400 mbar
Resolution	0.01 mbar
Accuracy	+/-0.5 mbar or 1% of reading
Selectable Units	Pa, hPa, kPa, PSI, inWG, mmWG, inHG, mmHG

## Temperature Measurements

Differential Temperature measurement (flow and return)	K-Type Thermocouple Measurement Range: -50°C to 1000°C Accuracy: $\pm 2^{\circ}\text{C}$ or 1.5% of reading
--	--

## Charger

Charging Temp Range	0°C – 40°C
Charger Input	USB-C
Required Charger Specification	<ul style="list-style-type: none"> <li>• USB A Output</li> <li>• UK Pin Type</li> <li>• DC output voltage: +5V +/- 0.25V</li> <li>• Minimum output current: 1A</li> <li>• Output Power: 5W</li> <li>• AC Input voltage: 90-264VAC, 50/60Hz</li> <li>• Operating Temperature 0 to 40 degrees C</li> <li>• Load Regulation: +/-5%</li> <li>• Ripple &amp; noise: 300mV p-p</li> <li>• Protection: Over Current, Over Voltage, Short Circuit</li> <li>• Certifications:               <ul style="list-style-type: none"> <li>o CE Mark</li> <li>o Designed to meet EN55022</li> <li>o ErP Level VI</li> <li>o RoHS</li> </ul> </li> </ul>

## Interfaces

IR Port	Report printing to IR printer.
USB-C	Charging & and PC connection.
Mobile apps	Supports use with Android and IOS apps Implements a dual mode device supporting Basic Rate (BR), Enhance Data Rate (EDR) & Low Energy (LE).

## VIII. Accessories and spare parts

### Accessory list

<b>Part number</b>	<b>Description</b>
<b>Flue Probes</b>	
C03738	Sprint Pro Flue Probe
M04202	Sprint Pro Flue Probe Connector & hose
M049003	Sprint Pro Filter Bowl & Filters
C01651	Sprint Pro Flue Probe Connector, hose, filter bowl & filters
M049002	Sprint Pro Water Filter
M049001	Sprint Pro Dust Filter
M03876	Sprint Pro Depth Gauge & Screw
M03877	Sprint Pro Cable Management Clip
C03767/S	Sprint Pro Oil Boiler Kit
C03771	Sprint Pro Oil Boiler Kit Spare 3 Micron Filter
<b>Gas Escape Probe</b>	Sprint Pro Gas Escape Probe
<b>Accessories</b>	
E01378	Sprint Pro USB Charger Lead
C03743	Sprinter (USB Charging)
PAP26001	Sprinter Paper Rolls
C03740	Sprint Pro Bag

## IX. Troubleshooting guide

Sprint Pro will provide on-screen messages which advise clear actions. Contact Anton by Crowcon if unsure on how to proceed.

Symptom	Cause	Recommended User Action:
Sprint Pro will not turn on when on/off button is pressed and held for 2 seconds.	Battery flat.	Connect charger and retry. Battery may be flat. Sprint Pro is designed to prevent deep discharge occurring and will turn it self off when battery level gets too low.
Sprint Pro will not turn on and charger symbol is not displayed when charger is connected.	Battery flattened beyond standard charging point.	Ensure charger is correct type. If so, plug-in and leave connected. If it does not switch on, return unit for service.
Blockage detected.	Filter/water trap or sample line blocked.	Empty and clean filter/water trap. Ensure sample line is free from blockage, shake water out of filter.
Printer does not respond or report contains odd characters.	Printer may be off, faulty, out of range, incorrectly set-up, have a low battery or not facing Sprint Pro.	Ensure printer is charged up and turned on, working, set-up correctly with 'PC' protocol, within physical range (usually 1m) and with the IR window facing the IR window on Sprint Pro. (Other IR sources such as a PC or sunlight may give odd character print-out.)
Zeroing process failed.	Sensors exposed to gas or maybe faulty.	Switch off and on, ensuring you zero in clean air and sensors are purged. If Sprint Pro continues to fail repeat zeroing process after a 15 minute wait, then please return for service.
Alarm activates in CO Room safety test.	CO is reading greater than 30ppm or 90ppm (cooker).	Dependant on safety procedures.

<b>Symptom</b>	<b>Cause</b>	<b>Recommended User Action:</b>
During the zeroing process the gas reading does not stabilise.	Recovering from high gas exposure or gas sensor faulty.	Ensure Sprint Pro is purged and allow 15 minutes for the sensor to recover. If it does not stabilise then please return for service.
Sometimes negative gas readings are displayed.	Previously zeroed with gas present.	Undertake the zeroing process using the Zero function in the Main Menu or turn off and on and repeat zero in clean outside air, allowing time for the CO sensor to recover and stabilise.
Sometimes “!>” or “!<” is displayed in place of a number.	Sensor is out of range.	Contact support for advice. Return for service if problem persists or other failures are observed. Sensors will generally recover in 15 minutes.
Cal due date has changed.	Time/date has been amended.	Check current date and time is correct. If the cal due date is set to more than a year's time then return for service.

# Appendix I: Room Safety Test

**Warning:** The CO and CO<sub>2</sub> alarms should be enabled before beginning room safety tests. It is possible to enable these alarms using the supervisor menu.

Sprint Pro is designed to assist heating engineers to work to the BS 7967 specification for carbon monoxide room safety testing. You should refer to BS7967, which defines the requirements, details the methods as well as the pass and fail criteria for various types of appliances.

Room Safety test in Sprint Pro is designed to measure the build up of carbon monoxide levels in a room where a gas appliance is in use and record those values each minute for the duration of the test. The CO<sub>2</sub> test measures for possible gas leaking into a room, or already present in a room. In addition at the end of the test it assists the engineer (in an advisory capacity only) to determine whether the test has passed or failed or if the results are invalid. In certain circumstances, where the results are borderline or open to interpretation, Sprint Pro will ask the operator to decide if the test has passed or failed, and will record the operators decision.

**Please note:** ultimately it is the responsibility of the operator to ensure that the test is correctly performed to the BS 7967 specification. If the data does not support the result or the operator suspects it is not reliable due to local conditions (such as carbon monoxide level changes due to cigarette smoke or vehicle traffic) or incorrect, then either the test should be repeated or the operator should seek expert advice.

## Room Test Pass and Fail Test Specifications

	Type C: Room sealed appliance	Type B: Boiler (open flue)	Type A: Cooker (flueless)	Type A: Water heater (flueless)	Type A: Space heater (flueless)
Max Allowed CO:	10ppm	10ppm	30ppm	10ppm	10ppm
Max Peak Duration exceeding Max Allowed CO:	60 secs	60 secs	20 mins	30 secs	60 secs
CO Alarm Level:	30ppm	30ppm	90ppm	30ppm	30ppm
Min Test Duration:	15 mins	15 mins	20 mins	5 mins	30 mins
Max Test Duration:	30 mins	30 mins	30 mins	10 mins	30 mins

## Result Codes

The pass or fail result is displayed when the test completes. If the test fails a code number is also displayed. This fail code identifies the way in which the test

failed and can help identify the cause. Also when the test completes a short text message associated to this code is displayed in a pop-up prompt dialogue screen, to explain the reason for failure.

The result codes and associated prompt dialogue messages are as follows:

<b>RESULT &amp; CODE</b>	<b>POP-UP PROMPT ON-SCREEN</b>
"PASSED "	None
"PASSED (2) "	None
ANY "FAILED"	"Warning - CO Room Safety test failed."
"FAILED (1) "	CO levels did not fall or unstable.
"FAILED (2) "	CO unacceptably high (for too long).
"FAILED (3) "	CO dangerously high.
"FAILED (4) "	Unacceptable or incomplete.
	<b>"Press ESC key to continue."</b>

## Pass Cases CO

### Normal Acceptable Peak of CO

Normally for a test to pass, the CO levels must peak without exceeding the maximum allowed CO level and then fall (by at least 1ppm) below the peak value before the end of the test. Note that it is not necessary for the CO level to reach or be close to zero at the end of the test, so long as it remains below the maximum allowed CO level.

### Very Low Levels of CO

If the CO levels remain below 3ppm (ie: close to clean air or background noise levels) for the duration of the test, then the test is considered to have passed.

## Failure Cases CO

### Excessive Levels of CO

**Note:** Please ensure the CO alarm is "Enabled" for this test.

When the measured CO level exceeds the CO alarm level, then the test is considered to have failed and should be immediately aborted. The CO alarm may be triggered at any stage (before, during and after completion of the test) and continues to annunciate until the CO level returns to a safe level.

If the CO level exceeds the CO alarm level then the test is considered to have failed and should be immediately aborted. The CO alarm may be triggered at

any stage (before, during and after completion of the test) and continues to announce until the CO level returns to a safe level.

**NB:** The alarm should prompt the operator to take appropriate action according to BS7967 and safety procedures. The sensors in Sprint Pro should be purged with clean air and allowed to recover.

### **Unacceptable Levels of CO**

A peak duration timer records whenever the CO level exceeds the maximum allowed CO level during the test. If the total peak duration time exceeds the max peak duration allowed then the test fails due to unacceptable levels of CO.

The result code is: **FAILED (2)**

**NB:** The alarm should prompt the operator to take appropriate action according to BS7967 and safety procedures. The sensors in Sprint Pro should be purged with clean air and allowed to recover.

### ***Operator Pass/Fail Cases***

The following results are considered to be operator determined whether the test passes or fails:

#### **CO Level Exceeds Max Allowable Level for a Short Duration**

For some appliances (eg: cooker) a peak exceeding the maximum allowed CO level may be acceptable, provided the CO level falls back below this level within the max peak duration time. It is up to the operator to determine if the result is acceptable or not.

If the operator chooses to fail the test, the result code is: **FAILED (4)**

Otherwise the result code is: **PASSED (2)**

### ***Other Cases***

When a test is not performed correctly, the results are inconclusive or there is insufficient or unreliable data Sprint Pro attempts to interpret the readings detected and fail the test. It is possible for the results of a test to appear to be valid when it was performed incorrectly or the data collected was unreliable in some way. Please refer to BS7967 and ensure tests are carried out correctly. Sprint Pro tries to reject incorrectly taken test readings but should not be relied on to instruct engineers on correct working practice.



### **Multiple Peaks of CO**

The overall peak CO reading recorded will be the latest peak CO reading that was higher than any previous. The peak duration recorded will be the total time the CO readings exceeded the maximum allowed CO level. The pass / fail criteria are applied as before based on this information. Sprint Pro does not expect to record multiple peaks of CO where the reading goes up and down more than once.

### **Unstable or Rising Levels of CO**

If there is a significant build up of CO levels at the end of the test and levels are still rising the test will fail.

The result code is: **FAILED (1)**

### **CO Level Exceeds Max Allowable Level and Peaks for Unknown Duration**

If the CO level exceeds the maximum allowed too close to the end of the test then the test is failed. This can occur if there is a build up of CO levels towards the end of the test or the appliance fires up late on in the test or the test is stopped too early. The test should be repeated if this occurs.

The result code is: **FAILED (2)**

### **CO Level Does Not Start Close to Zero**

It is important that the Sprint Pro undertakes the zeroing process in clean air at switch-on. Failure to do so will invalidate the test result. BS 7967-2 also requires that the room is well ventilated prior to starting the test. However it is possible that there may be a residual background CO level (eg: due to traffic fumes). The Sprint Pro will display a pop-up box prior to starting the test if the CO level is more than 3ppm.

---

# Warranty

---

The Supplier shall provides a five (5) years manufacturer's warranty for the Sprint Pro with the following exclusions:

- i. The defect arises because the customer failed to follow the manufacturer's oral or written instructions as to the storage, use and maintenance of the goods or (if there are none) good trade practice regarding the same.
- ii. The defect arises as a result of fair wear and tear, wilful damage, negligence, or abnormal storage or working conditions.
- iii. The defect arises as a result of alterations or repairs that have been undertaken by an unapproved or untrained service agent.
- iv. The charger, probes, printer, bag and all accessories are warranted for one (1) year against production fault only.
- v. Batteries are warranted for three (3) years and must not be charged below 0 degrees centigrade or above 40 degrees centigrade, any warranty claim under these conditions will be deemed void.
- vi. Frequent use (more than 5000 times) with Oil and Coal burning boilers will void warranty claims against the CO sensor. All maintenance on these boilers should be performed using an in-line NOX filter and guidance is offered in the manual to this effect.
- vii. Pumps are warranted for 2000 working hours or five (5) years; whichever is the lesser, any claims will be void if the pump has been flooded or particulates have been allowed to ingress into the pump due to misuse and negligence.
- viii. All consumables are excluded from the warranty, these include but are not limited to filters (including the filter connector on the flue probe), O Rings, water trap, tubing and any other consumables listed or shown in the manual.
- ix. For NO sensor warranty is limited to 2 years. The CO<sub>2</sub>, CO and O<sub>2</sub> sensor warranty is covered by the 5 year warranty on the product.

---

## Sprint Pro Warranty Limitations

---

- The warranty may be invalidated if the case is opened and the tamper proof paint is damaged.
- Sprint Pro must not be operated outside the temperature range -10°C to +50°C, this will be recorded internally and may invalidate the warranty.
- Sprint Pro must only be operated with the Sprint Pro Flue Probe assembly attached and always with the water trap and filters in place or this may invalidate the warranty.
- Warranty may be invalidated if the pump is flooded or particulates have been allowed to ingress into the pump due to "misuse and negligence".
- Sprint Pro's battery must not be charged at temperatures below 0°C or above 40°C as this may invalidate the warranty.
- All batteries degrade in performance over time and usage, a reduction in run time over the period of the warranty should be expected.
- Carbon Monoxide sensor life will be reduced if testing is undertaken on 'oil' based fuels due to NOx exposure and as such the warranty period of the carbon monoxide sensor will be reduced. Where 'oil' is selected as the fuel, the CO sensor will be warranted for a total of 5,000 tests or approximately 65,000ppm hrs of NO for these tests. Where practical Crowcon recommend the use of the NOx filter to extend the life of the CO sensor when fuels such as 'oil' are used.
- Overgassing of Carbon Monoxide sensor will damage the sensor and may invalidate the warranty, overgassing is determined as more than 10,000ppm of carbon monoxide.
- Overgassing of Nitric Oxide sensor will damage the sensor and will invalidate the warranty, overgassing is determined as more than 800ppm of Nitric Oxide.
- If Sprint pro is subjected to a significant impact or shock this may invalidate the warranty.
- Expected Life Times:
  - Battery: 3 to 5 years
  - CO Sensor: 5 years
  - O<sub>2</sub> Sensor: 5 years
  - NO Sensor: 2 years
  - CO<sub>2</sub> Sensor: 5 years







*Technical helpline: +44 (0)1235 557780*

***Manufactured and sold by:***

Crowcon Detection Instruments Ltd

172 Brook Drive

Milton Park

Abingdon

Oxfordshire, OX14 4SD

United Kingdom

Tel: +44 (0)1235 557780

Fax: +44 (0)1235 557749

Email: [customersupport@crowcon.com](mailto:customersupport@crowcon.com)

Website: [www.crowcon.com](http://www.crowcon.com)



A HALMA COMPANY